

ODSL 9

Optical laser distance sensors

en 03-2012/11 50112186



Dimensioned drawing

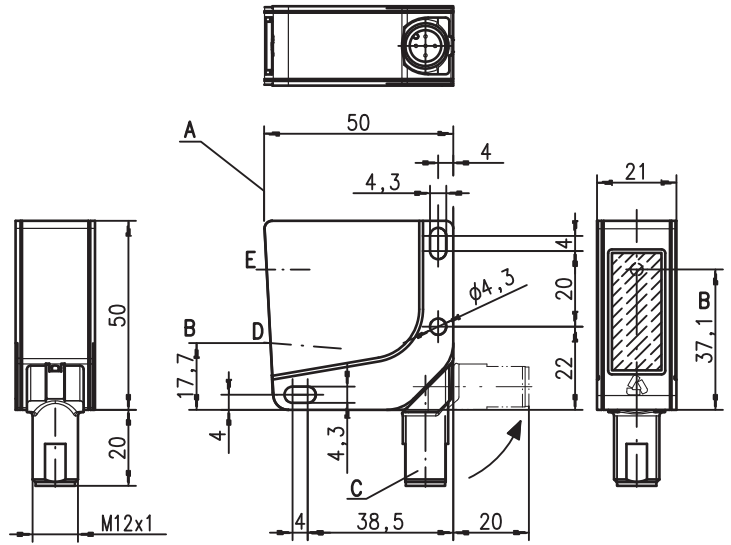

- A Reference edge for the measurement
- B Optical axis
- C Device plug M12
- D Receiver
- E Transmitter
- F LCD display
- G Indicator diode yellow
- H Indicator diode green
- J Control buttons

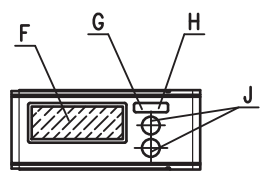

50 ... 100mm

18 - 30 V DC

- High resolution 0.01 mm
- Reflection-independent distance information
- Configuration via PC/LC display and control buttons
- Measurement value is indicated with 0.01 mm resolution on LC display
- Configurable measure mode and measurement range
- Input (pin 2) for deactivating the laser, triggering, offset correction, reference measurement or teach-in
- M12 turning connector
- Fieldbus connection (e.g. PROFINET, PROFIBUS, ...) with a MA2xxi modular interfacing unit for ODSL 9/D26...

Electrical connection

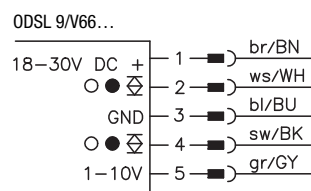
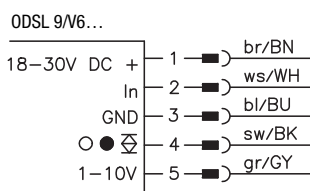
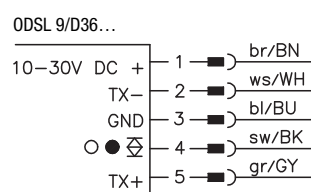
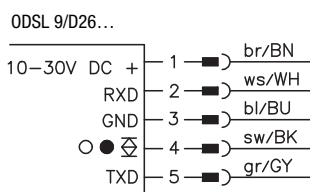
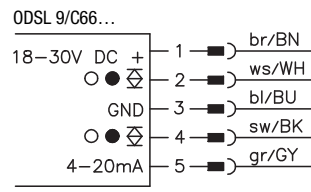
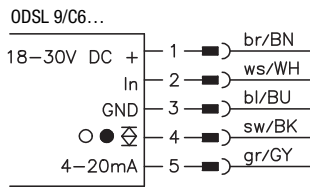
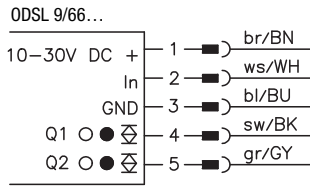

CE

IP 67

CDRH

IEC 60947...

IEC 60947...

Accessories:

- (available separately)
- Mounting systems
 - Configuration software
 - Cable with M12 connector (K-D ...)
 - Connection cable for MA2xxi (K-DS M12A-MA-5P-3m-S-PUR, Part no. 50115049)

We reserve the right to make changes • DS_ODSL9100_en_50112186.fm

Specifications

Optical data

Measurement range ¹⁾	50 ... 100mm
Resolution	0.01 mm
Light source	laser
Wavelength	655nm
Light spot	divergent, 1x1mm ² at 100mm
Laser warning notice	see remarks

Error limits (relative to measurement distance)

Absolute measurement accuracy ¹⁾	± 0.5%
Repeatability ²⁾	± 0.25%
B/W detection thresh. (6 ... 90% rem.)	≤ 0.5%
Temperature compensation	yes ³⁾

Timing

Measurement time	2ms
Response time ¹⁾	≤ 6ms
Delay before start-up	≤ 300ms

Electrical data

Operating voltage U _B	...C6/C66/V6/V66 ...D26/D36/66	18 ... 30VDC (incl. residual ripple) 10 ... 30VDC (incl. residual ripple)
Residual ripple		≤ 15% of U _B
Open-circuit current		≤ 180mA
Switching output		push-pull switching output ⁴⁾ , PNP light switching, NPN dark switching
Signal voltage high/low		≥ (U _B -2 V)/≤ 2V
Analog output	...V6/V66 ...C6/C66	voltage 1 ... 10V / 0 ... 10V / 1 ... 5V / 0 ... 5V, R _L ≥ 2kΩ current 4 ... 20mA, R _L ≤ 500Ω
Serial interface	...D26/D36	RS 232/RS 485, 9600 ... 57600Bd, 1 start bit, 8 data bits, 1 stop bit, no parity
Transmission protocol		14 bit, 16 bit, ASCII, Remote Control

Indicators

		Teach-in on GND	Teach-in on +U _B
Green LED	continuous light flashing off	ready fault no voltage	teaching procedure
Yellow LED	continuous light flashing off	object inside teach-in measurement distance object outside teach-in measurement distance	teaching procedure

Mechanical data

Housing	plastic
Optics cover	glass
Weight	approx. 50g
Connection type	M12 connector, 5-pin

Environmental data

Ambient temp. (operation/storage)	-20°C ... +50°C / -30°C ... +70°C
Protective circuit ⁵⁾	1, 2, 3
VDE safety class ⁶⁾	II, all-insulated
Protection class	IP 67
Laser class	2 (according to EN 60825-1 and 21 CFR 1040.10 with Laser Notice No. 50)
Standards applied	IEC 60947-5-2

- 1) Luminosity coefficient 6% ... 90%, complete measurement range, "Standard" operating mode, at 20°C, medium range of U_B, measurement object ≥ 50x50mm²
 2) Same object, identical environmental conditions, measurement object ≥ 50x50mm²
 3) Typ. ± 0.02 %/K
 4) The push-pull switching outputs must not be connected in parallel
 5) 1=transient protection, 2=polarity reversal protection, 3=short circuit protection for all outputs
 6) Rating voltage 50VAC

Order guide

	Designation	Part No.
Analog current output		
1 teachable push/pull output	ODSL 9/C6-100-S12	50111167
2 push/pull outputs	ODSL 9/C66-100-S12	50111171
Analog voltage output		
1 teachable push/pull output	ODSL 9/V6-100-S12	50111168
2 push/pull outputs	ODSL 9/V66-100-S12	50111172
Serial digital output		
RS 232, 1 push/pull output	ODSL 9/D26-100-S12	50111169
RS 485, 1 push/pull output	ODSL 9/D36-100-S12	50111170
Only switching outputs		
2 teachable push/pull outputs	ODSL 9/66-100-S12	50111173

Tables

Diagrams

Remarks

- Measurement time depends on the reflectivity of the measurement object and on the measurement mode.
- **Approved purpose:** This product may only be used by qualified personnel and must only be used for the approved purpose. This sensor is not a safety sensor and is not to be used for the protection of persons.

ODSL 9

Optical laser distance sensors

Analog output: characteristic curve for factory setting

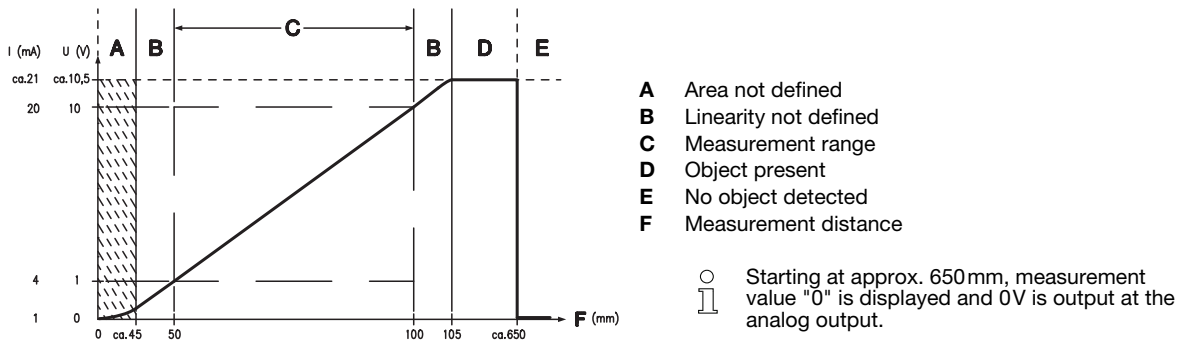

Serial output: transmission protocol for factory setting

9600Bd, 1 start bit, 8 data bits, 1 stop bit,
 transmission protocol ASCII measurement values

Transmission format: **MMMMM<CR>**

MMMMM = 5-digit measurement value in mm (resolution 0.01 mm)

<CR> = ASCII character "Carriage Return" (x0D)

Operation of ODSL 9/D26... with MA2xxi modular interfacing unit

Set **S4** rotary switch for device selection in MA 2xxi to switch position "**B**" (AMS)
 (see MA 2xxi Technical description).

Set the serial interface of the ODSL 9/D26... to:

- ASCII (factory setting)
- Baud rate: 38400Bd (see ODSL 9 Technical description...)

